

FEATURES

Electrical

- ◆ Typical efficiency up to 96%
- ◆ PMBus communication
- ◆ Fully protected: Input UVP, output OVP, OCP and OTP
- ◆ Remote ON/OFF
- ◆ Monotonic and Pre-bias startup
- ◆ No minimum load required
- ◆ 2250Vdc isolation

Mechanical

Size:

58.4x22.8x12.7mm (2.30"x0.90"x0.50")

Safety & Certificate

- ◆ IEC/EN/UL/CSA 62368-1, 2nd edition
- ◆ IEC/EN/UL/CSA 60950-1, 2nd edition+A2
- ◆ ISO 9001, TL 9000, ISO 14001, QS 9000,
- ◆ OHSAS18001 certified manufacturing facility



Photo is for reference only

E48SK12038

Eighth Brick DC/DC Power Module
36~75V in, 10.8~12V/37.5A out, 450W

E48SK12038, eighth brick, 36~75V input, single output 12V, isolated DC/DC converter is the latest offering from a world leader in power system and technology and manufacturing — Delta Electronics, Inc. This product provides up to 450 watts of power at 36~75V input in an industry standard footprint and pin out. With creative design technology and optimization of component placement, these converters possess outstanding electrical and thermal performances, as well as extremely high reliability under highly stressful operating conditions. The E48SK12038 offers typical 96% high efficiency. It can be trimmed to a very wide range of output voltage. The E48SK12038 is fully protected from abnormal input/output voltage, current, and temperature conditions and meets 2250V isolation.

OPTIONS

- ◆ Negative/Positive Remote on/off
- ◆ Optional PMBus Pins

APPLICATIONS

- ◆ Optical Transport
- ◆ Data Networking
- ◆ Communications
- ◆ Servers

SOLDERING METHOD

- ◆ Wave soldering
- ◆ Hand soldering
- ◆ Reflow soldering (MSL of rating 3)

($T_A=25^{\circ}\text{C}$, airflow rate=300 LFM, $V_{in}=48\text{Vdc}$, nominal V_{out} unless otherwise noted.)

PARAMETER	NOTES and CONDITIONS	Min.	Typ.	Max.	Units
ABSOLUTE MAXIMUM RATINGS					
Input Voltage					Vdc
Continuous		0		75	Vdc
Transient	100mS			80	Vdc
Operating Ambient Temperature (T_a)		-40		85	$^{\circ}\text{C}$
Operating Module Temperature (T_h)	Hot Spot's Temperature (Refer to Figure 17 for Hot spot's location)	-40		124	$^{\circ}\text{C}$
Storage Temperature		-55		125	$^{\circ}\text{C}$
Input/Output Isolation Voltage				2250	Vdc
INPUT CHARACTERISTICS					
Operating Input Voltage		36	48	75	Vdc
Input Under-Voltage Lockout					
Turn-On Voltage Threshold		33		36	Vdc
Turn-Off Voltage Threshold		31		34	Vdc
Lockout Hysteresis Voltage			2		Vdc
Maximum Input Current	Full Load, $36V_{in}$			13.9	A
No-Load Input Current	$V_{in}=48\text{V}$, $I_o=0\text{A}$		100		mA
Off Converter Input Current	$V_{in}=48\text{V}$		30		mA
Inrush Current	With 100uF Aluminum Capacitor			1	A^2S
Internal Input Ripple Current	$V_{in}=48\text{V}$, $I_o=37.5\text{A}$, P-P thru 12uH inductor		200		mArms
Input Voltage Rejection	At 120Hz		40		dB
OUTPUT CHARACTERISTICS					
Output Voltage Set Point	$V_{in}=36\text{V}\sim 38\text{V}$, $I_o=\text{Open Load}$, $T_c=25^{\circ}\text{C}$	10.6	10.8	11.7	Vdc
	$V_{in}=38\text{V}\sim 40\text{V}$, $I_o=\text{Open Load}$, $T_c=25^{\circ}\text{C}$	10.6	11.5	12.12	Vdc
	$V_{in}=40\text{V}\sim 75\text{V}$, $I_o=\text{Open Load}$, $T_c=25^{\circ}\text{C}$	11.88	12	12.12	Vdc
Output Regulation					
Load Regulation	$V_{in}=48\text{V}$, $I_o=I_{o\text{min}}$ to $I_{o\text{max}}$			+/-0.5	% $V_{o,\text{set}}$
Line Regulation	$V_{in}=40\text{V}$ to 75V , $I_o=0$			+/-0.5	% $V_{o,\text{set}}$
Temperature Regulation	$T_a=-40^{\circ}\text{C}$ to 85°C			+/-1	% $V_{o,\text{set}}$
Total Output Voltage Range	Over sample load, 40V-75Vin and temperature	11.64	12	12.36	V
Output Voltage Ripple and Noise	5Hz to 20MHz bandwidth				
Peak-to-Peak	Full Load, $C_o=470\mu\text{F}$, 1uF ceramic, 10uF tantalum		50		mV
RMS	Full Load, $C_o=470\mu\text{F}$, 1uF ceramic, 10uF tantalum		15		mV
Operating Output Current Range	36V-75Vin	0		37.5	A
Output Over Current Protection(hiccup mode)	when $V_o<10\%V_{o,\text{nom}}$	41.25		52.5	A
Output Over Voltage Protection(hiccup mode)		14	15	17	V
Output voltage trim range (note1)	Trim pin	8		13.2	V
DYNAMIC CHARACTERISTICS					
Output Voltage Current Transient	470uF Oscon & 1uF Ceramic load cap, 1A/us				
Positive Step Change in Output Current	75% $I_{o,\text{max}}$ to 50% $I_{o,\text{max}}$		360		mV
Negative Step Change in Output Current	50% $I_{o,\text{max}}$ to 75% $I_{o,\text{max}}$		-360		mV
Settling Time (within 1% nominal V_{out})			500		us
Turn-On Delay Time					
Start-Up Delay Time From Input Voltage	On/Off=On, from $V_{in}=\text{Turn-on Threshold}$ to $V_o=10\%V_{o,\text{nom}}$		50		mS
Start-Up Delay Time From On/Off Control	$V_{in}=V_{in,\text{nom}}$, from On/Off=On to $V_o=10\%V_{o,\text{nom}}$		20		mS
Output Voltage Rise Time	$V_o=10\%$ to $90\%V_{o,\text{nom}}$		70		mS
Output Capacitance		330		15000	uF
EFFICIENCY					
100% Load	$V_{in}=48\text{V}$, $I_o=\text{Full Load}$, $T_c=25^{\circ}\text{C}$		95.6		%
60% Load	$V_{in}=48\text{V}$, $I_o=60\%$ Load, $T_c=25^{\circ}\text{C}$		96		%
ISOLATION CHARACTERISTICS					
Input to Output				2250	Vdc
Isolation Capacitance			4.7		nF
FEATURE CHARACTERISTICS					
Switching Frequency			250		KHz
On/Off Control, Negative Remote On/Off logic					
Logic Low (Module On)	$V_{on/off}$			0.8	V
Logic High (Module Off)	$V_{on/off}$	3.5		10	V
ON/OFF Current	$I_{on/off}$ at $V_{on/off}=0.0\text{V}$			1.5	mA
Leakage Current	Logic High, $V_{on/off}=5\text{V}$		1		mA
GENERAL SPECIFICATIONS					
MTBF	Normal input, $I_o=88\%$ of $I_{o,\text{max}}$; $T_{\text{baseplate}}=40^{\circ}\text{C}$	5.7			Mhours
Weight	With heat-spreader		44		grams
Over-Temperature Shutdown (With heat-spreader)	Refer to Figure 17 for Hot spot 1 location (48Vin, 80% I_o , 200LFM, Airflow from V_{in+} to V_{in-})		136		$^{\circ}\text{C}$
Over-Temperature Shutdown (With heat sink ETL050A)	Refer to Figure 19 for Hot spot 2 location (48Vin, 80% I_o , 200LFM, Airflow from V_{in+} to V_{in-})		136		$^{\circ}\text{C}$
Over-Temperature Shutdown (With heat sink ELL050A)	Refer to Figure 21 for Hot spot 3 location (48Vin, 80% I_o , 200LFM, Airflow from Input to Output)		136		$^{\circ}\text{C}$
Over-Temperature Shutdown (NTC resistor)			135		$^{\circ}\text{C}$
Note1: Output voltage trim up range limited at $V_{in}<40\text{V}$.					
Note2: Please attach thermocouple on NTC resistor to test OTP function, the hot spots' temperature is just for reference.					

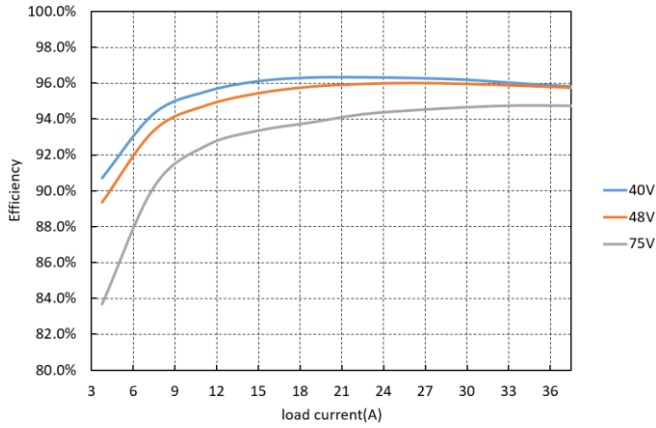

Figure 1: Efficiency vs. load current for 40V, 48V, and 75V input voltage and 12V output voltage at 25°C.

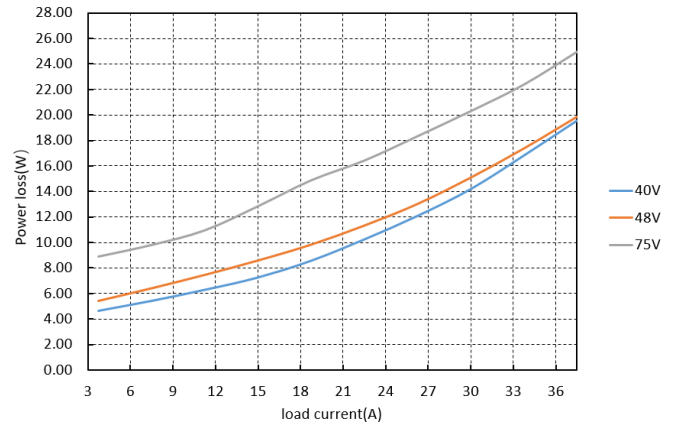

Figure 2: Loss vs. load current for 40V, 48V, 75V input voltage and 12V output voltage at 25°C.

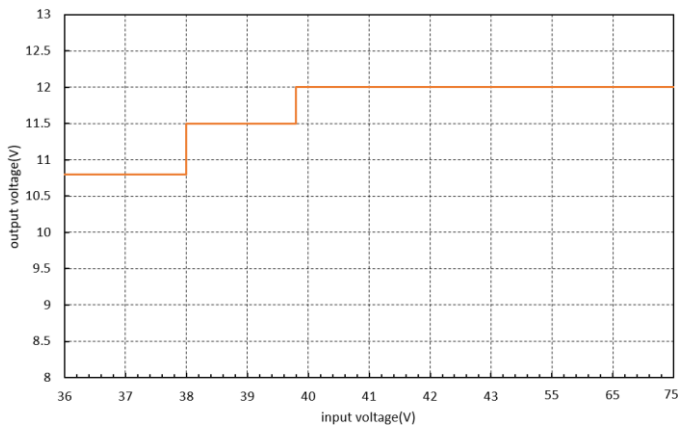

Figure 3: Output voltage vs. input voltage for open load at 25°C.

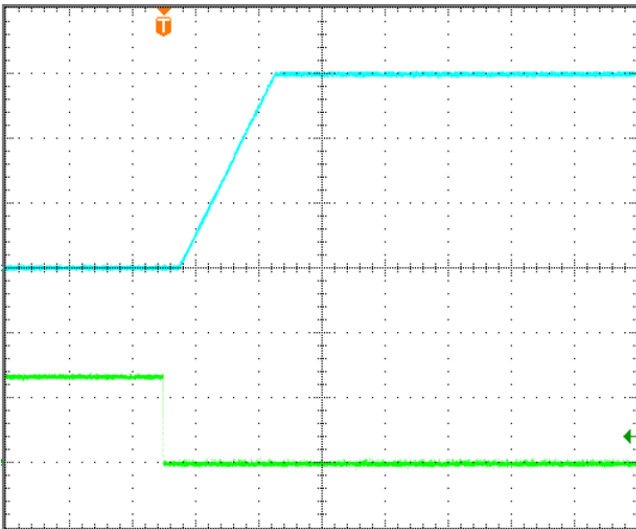

Figure 4: Remote On/Off(negative logic) at full load

$V_{in}=48V$, $I_{out}=37.5A$
 Time: 40ms/div.
 V_{out} (top trace): 4V/div;
 $V_{remote\ On/Off\ signal}$ (bottom trace): 5V/div.

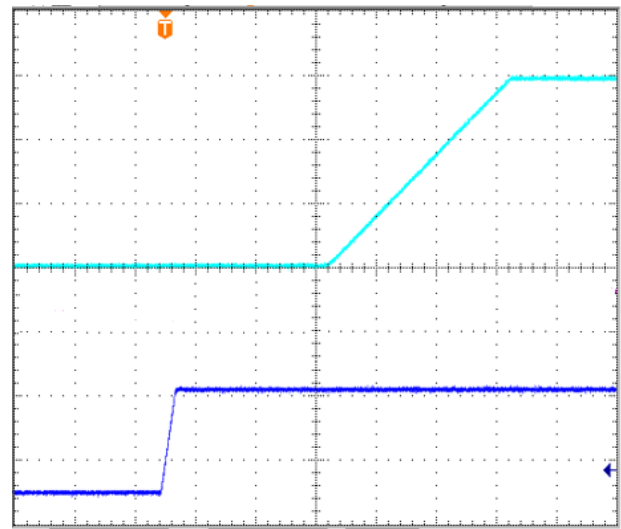

Figure 5: Input Voltage Start-up at full load

$V_{in}=48V$, $I_{out}=37.5A$
 Time: 20ms/div.
 V_{out} (top trace): 4V/div;
 V_{in} (bottom trace): 30V/div.

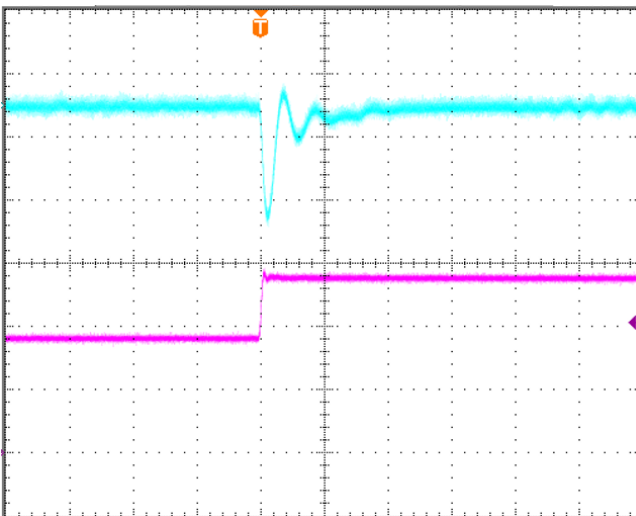

Figure 6: Transient Response

($V_{in}=48V$, 1A/ μs step change in load from 50% to 75% of $I_{o,max}$)
 V_{out} (top trace): 200mV/div, 200us/div;
 I_{out} (bottom trace): 10A/div.
 Scope measurement should be made using a BNC cable (length shorter than 20 inches). Position the load between 51 mm to 76 mm (2 inches to 3 inches) from the module
 470uF Oscon Cap and 50uF Ceramic Cap

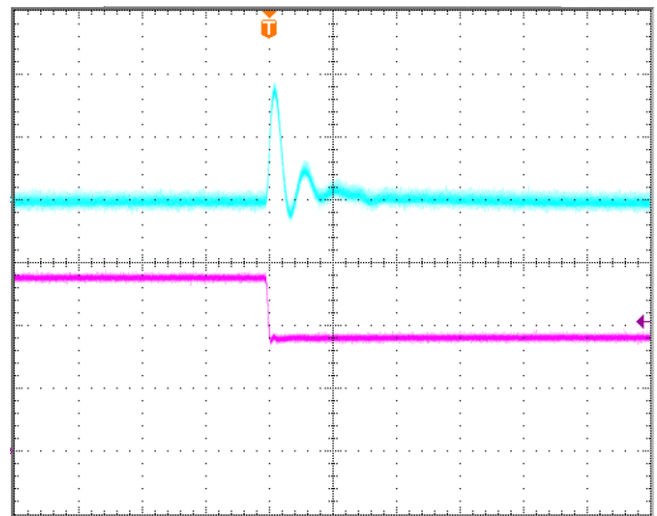
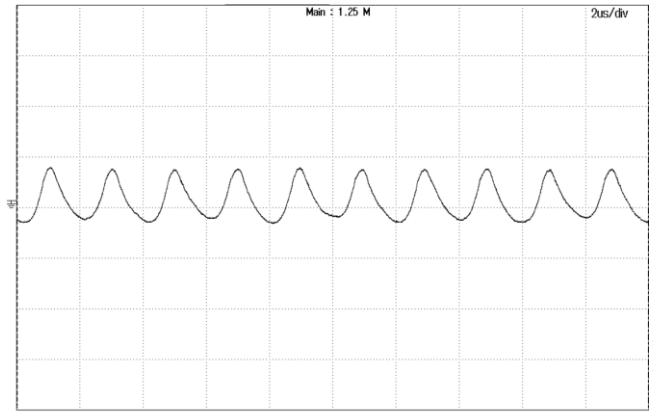
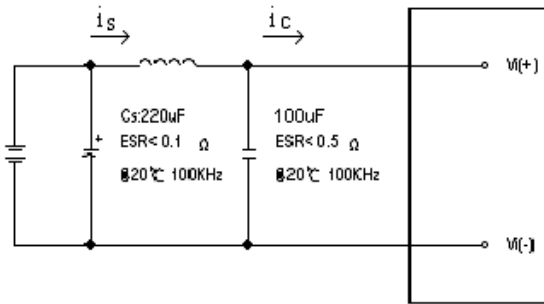

Figure 7: Transient Response

($V_{in}=48V$, 1A/ μs step change in load from 75% to 50% of $I_{o,max}$)
 V_{out} (top trace): 200mV/div, 200us/div;
 I_{out} (bottom trace): 10A/div.
 Scope measurement should be made using a BNC cable (length shorter than 20 inches). Position the load between 51 mm to 76 mm (2 inches to 3 inches) from the module
 470uF Oscon cap and 50uF Ceramic Cap



P-P(C3) 566mA Rms(C3) 173.147mA

Figure 8: Test Setup Diagram for Input Ripple Current

Note: Measured input reflected-ripple current with a simulated source inductance of 12μH. Measure current as shown above.

Figure 9: Input Terminal Ripple Current, i_c , at max output current and nominal input voltage with 12μH source impedance and 100μF electrolytic capacitor (500 mA/div, 2us/div).

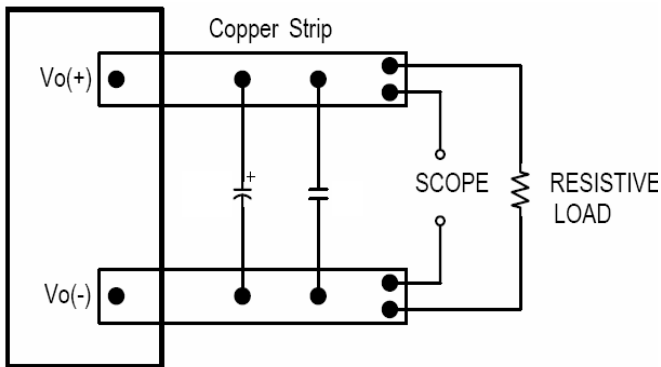
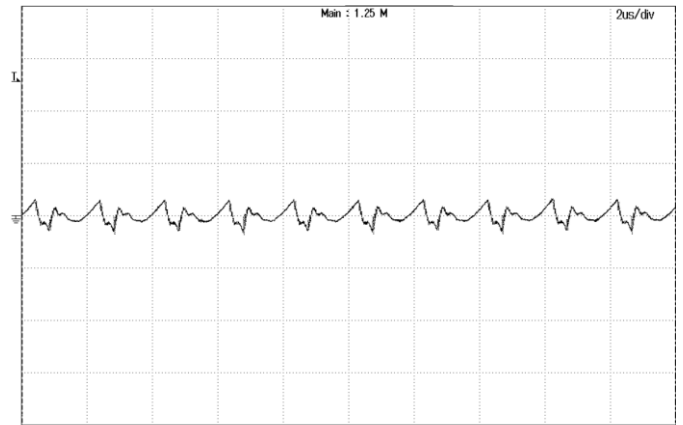

Figure 10: Test Setup for Output Voltage Noise and Ripple



P-P(C4) 34.3mV Rms(C4) 6.28480mV

Figure 11: Output Voltage Ripple and Noise at nominal input voltage and max load current (50 mV/div, 2us/div) Load cap: 470uF Oscon cap. Bandwidth: 20MHz.

Input Source Impedance

The impedance of the input source connecting to the DC/DC power modules will interact with the modules and affect the stability. A low ac-impedance input source is recommended. A low ESR electrolytic capacitor higher than 100 μ F (ESR < 0.7 Ω at 100kHz) is suggested.

Layout and EMC Considerations

Delta's DC/DC power modules are designed to operate in a wide variety of systems and applications. For design assistance with EMC compliance and related PWB layout issues, please contact Delta's technical support team.

Schematic and Components List

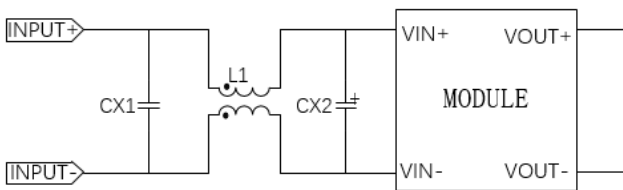

Location	Component
CX1	2.2 μ F
L1	P0502NL-0.47mH-Pulse
CX2	220 μ F/100V+2.2 μ F

Figure 12-1: Recommended Input Filter

Test result:

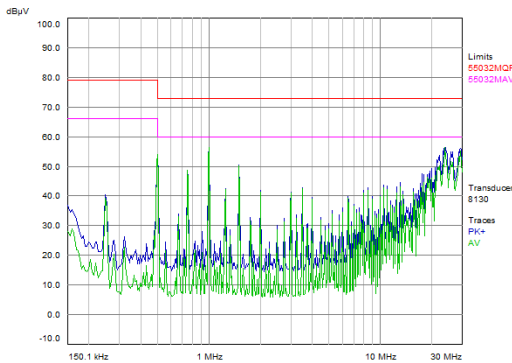

Figure 12-2: Test Result of EMC ($V_{in}=48V$, $I_o=37.5A$).

Safety Considerations

The power module must be installed in compliance with the spacing and separation requirements of the end-user's safety agency standard, i.e. IEC 62368-1: 2014 (2nd edition), EN 62368-1: 2014 (2nd edition), UL 62368-1, 2nd Edition, 2014-12-01 and CSA C22.2 No. 62368-1-14, 2nd Edition, 2014-12. IEC 60950-1: 2005, 2nd Edition + A1: 2009 + A2: 2013, EN 60950-1: 2006 + A11: 2009 + A1: 2010 + A12: 2011 + A2: 2013, UL 60950-1, 2nd Edition, 2011-10-14 and CSA C22.2 No. 60950-1-07, 2nd Edition, 2010-14, if the system in which the power module is to be used must meet safety agency requirements.

Basic insulation based on 72 Vdc input is provided between the input and output of the module for the purpose of applying insulation requirements when the input to this DC-to-DC converter is identified as TNV-2 or SELV. An additional evaluation is needed if the source is other than TNV-2 or SELV.

When the input source is SELV circuit, the power module meets SELV (safety extra-low voltage) requirements. If the input source is a hazardous voltage which is greater than 60 Vdc and less than or equal to 72 Vdc, for the module's output to meet SELV requirements, all of the following must be met:

- The input source must be insulated from the ac mains by reinforced or double insulation.
- The input terminals of the module are not operator accessible.
- A SELV reliability test is conducted on the system where the module is used, in combination with the module, to ensure that under a single fault, hazardous voltage does not appear at the module's output.

When installed into a Class II equipment (without grounding), spacing consideration should be given to the end-use installation, as the spacing between the module and mounting surface have not been evaluated.

This module has basic insulation with 2250Vdc isolation.

This power module is not internally fused. To achieve optimum safety and system protection, an input line fuse is highly recommended. The safety agencies require a fast-acting fuse with 20A maximum rating to be installed in the ungrounded lead. A lower rated fuse can be used based on the maximum inrush transient energy and maximum input current.

Remote On/Off

The remote on/off feature on the module is negative logic. Negative logic turns the module on during a logic low and off during a logic high. Remote on/off can be controlled by an external switch between the on/off terminal and the V_i (-) terminal. The switch can be an open collector or open drain.

For negative logic if the remote on/off feature is not used, please short the on/off pin to V_i (-).

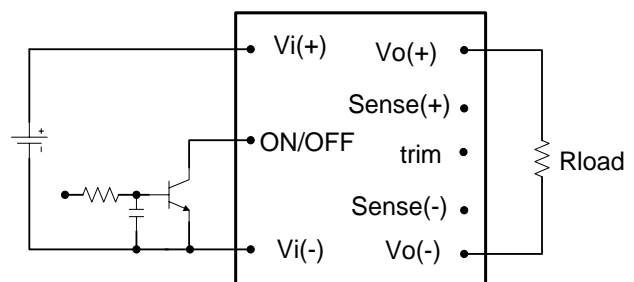

Figure 13: Remote On/Off Implementation

Over-Current Protection

The modules include an internal output over-current protection circuit, which will endure current limiting for an unlimited duration during output overload. If the output current exceeds the OCP set point, the modules will shut down (hiccup mode).

The modules will try to restart after shutdown. If the overload condition still exists, the module will shut down again. This restart trial will continue until the overload condition is corrected.

Over-Voltage Protection

The modules include an internal output over-voltage protection circuit, which monitors the voltage on the output terminals. If this voltage exceeds the over-voltage set point, the protection circuit will shut down, and then restart with a time delay after the fault no longer exist.

Over-Temperature Protection

The over-temperature protection consists of circuitry that provides protection from thermal damage. If the temperature exceeds the over-temperature threshold the module will shut down. The module will restart after the temperature is within specification.

Remote Sense

Remote sense minimizes the effects of distribution losses by regulating the voltage at the remote-sense connections. The SENSE (-) pin should be always connected to VO(-) pin. The voltage between the remote-sense pins and the output terminals must not exceed the output voltage sense range given in the Feature Specifications

$$\begin{aligned} VO(+)-SENSE(+)&\leq 1.2\text{ V} \\ SENSE(-)-VO(-)&\leq 0.12\text{ V} \end{aligned}$$

The output voltage can also be increased by the trim, the maximum increase for the output voltage is the sum of both. The amount of power delivered by the module is defined as the voltage at the output terminals multiplied by the output current. When using remote sense and trim, the output voltage of the module can be increased, which at the same output current, would increase the power output of the module. Care should be taken to ensure that the maximum output power of the module remains at or below the maximum rated power (Maximum rated power = $V_{o,set} \times I_{o,max}$)

Output Voltage Adjustment (Analog TRIM)

To increase or decrease the output voltage set point, connect an external resistor between the TRIM pin and either the Sense (+) or Sense(-). The TRIM pin should be left open if this feature is not used.

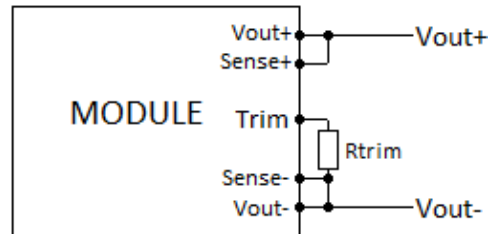

Figure 14: Circuit configuration for trim-down (decrease output voltage)

If the external resistor is connected between the TRIM and Sense (-) pins, the output voltage set point decreases (Fig. 14). The external resistor value required to obtain a percentage of output voltage change $\Delta\%$ is defined as:

$$R_{trim_down} = \left[\frac{511}{\Delta} - 10.2 \right] (K\Omega)$$

Ex. When Trim-down -10% ($12V \times 0.9 = 10.8V$)

$$R_{trim_down} = \left[\frac{511}{10} - 10.22 \right] (K\Omega) = 40.88(K\Omega)$$

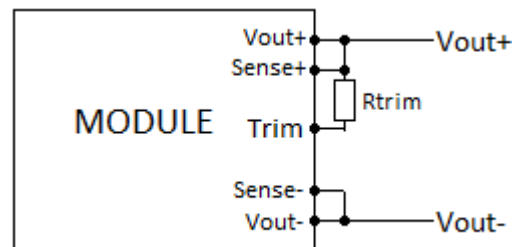

Figure 15: Circuit configuration for trim-up (increase output voltage)

If the external resistor is connected between the TRIM and Sense (+) the output voltage set point increases (Fig.15) The external resistor value required to obtain a percentage output voltage change $\Delta\%$ is defined as:

$$R_{trim_up} = \frac{5.11V_o(100 + \Delta)}{1.225\Delta} - \frac{511}{\Delta} - 10.2(K\Omega)$$

Ex. When Trim-up +10% ($12V \times 1.1 = 13.2V$)

$$R_{trim_up} = \frac{5.11 \times 12 \times (100 + 10)}{1.225 \times 10} - \frac{511}{10} - 10.2 = 489.3(K\Omega)$$

Thermal Testing Setup

Thermal management is an important part of the system design. To ensure proper, reliable operation, sufficient cooling of the power module is needed over the entire temperature range of the module. Convection cooling is usually the dominant mode of heat transfer.

Hence, the choice of equipment to characterize the thermal performance of the power module is a wind tunnel.

Delta's DC/DC power modules are characterized in heated vertical wind tunnels that simulate the thermal environments encountered in most electronics equipment. This type of equipment commonly uses vertically mounted circuit cards in cabinet racks in which the power modules are mounted.

The following figure shows the wind tunnel characterization setup. The power module is mounted on a 185mmX185mm, 105µm (3Oz),6 layers' test PWB and is vertically positioned within the wind tunnel. The space between the neighboring PWB and the top of the power module is constantly kept at 6.35mm (0.25").

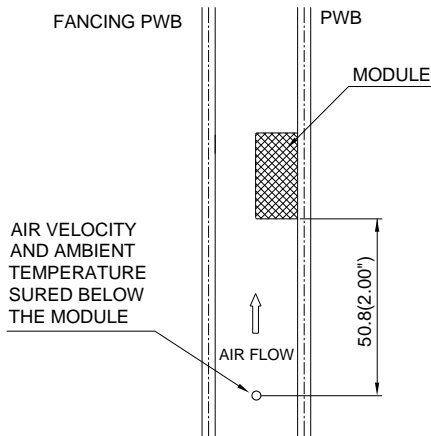

Note: Wind Tunnel Test Setup Figure Dimensions are in millimeters and (l

Figure 16: Wind Tunnel Test Setup

Thermal De-rating

Heat can be removed by increasing airflow over the module. To enhance system reliability, the power module should always be operated below the maximum operating temperature. If the temperature exceeds the maximum module temperature, reliability of the unit may be affected.

Thermal Curves (with heat spreader)

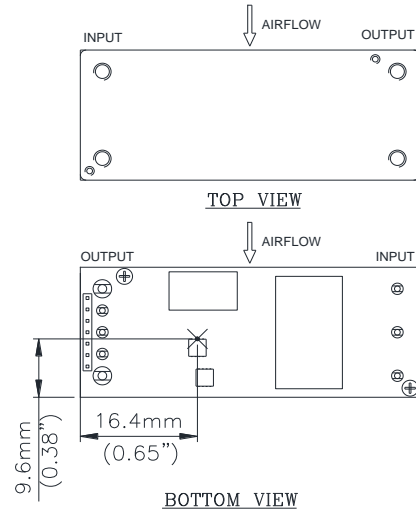

Figure 17: Hot spot 1 temperature measurement location
The allowed maximum hot spot 1 temperature is defined at 124 °C.

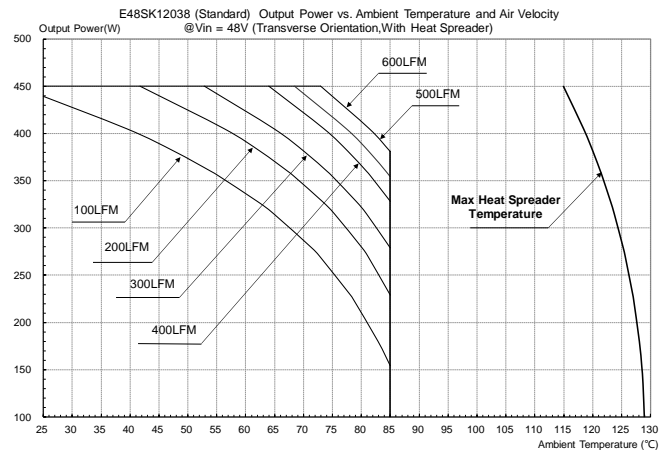

Figure 18: Output Power vs. Ambient Temperature and Air Velocity @ Vin = 48V (Transverse Orientation, Airflow from Vin+ to Vin-, With Heat Spreader)

Thermal Curves (with 0.5" height heat sink ETL050A)

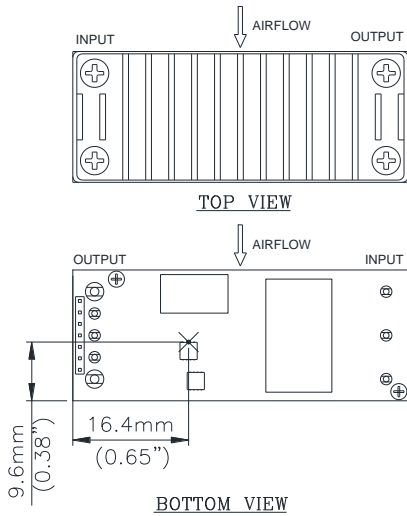

Figure 19: Hot spot 2 temperature measurement location
The allowed maximum hot spot 2 temperature is defined at 124 °C.

Thermal Curves (with 0.5" height heat sink ELL050A)

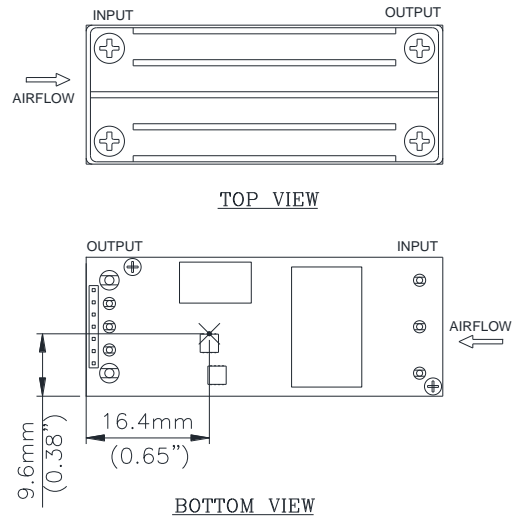

Figure 21: Hot spot 3 temperature measurement location
The allowed maximum hot spot 3 temperature is defined at 124 °C.

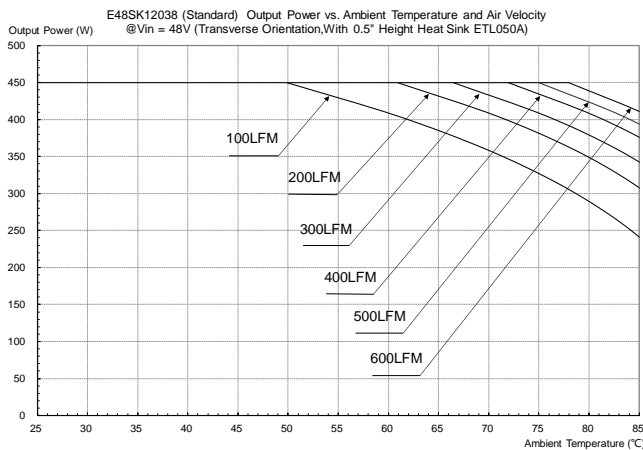

Figure 20: Output Power vs. Ambient Temperature and Air Velocity @ Vin = 48V (Transverse Orientation, Airflow from Vin+ to Vin-, With 0.5" Height Heat Sink ETL050A)

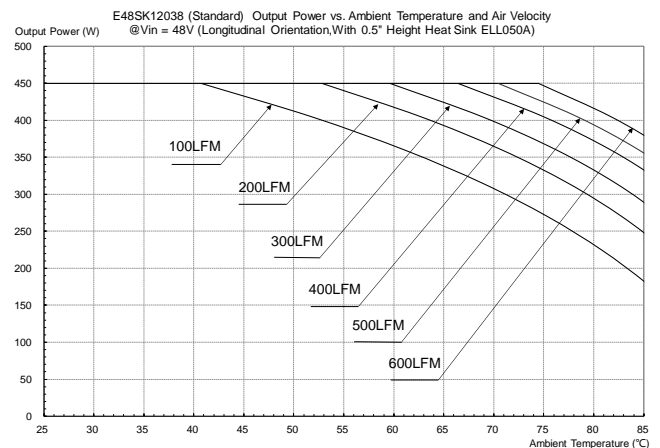

Figure 22: Output Power vs. Ambient Temperature and Air Velocity @ Vin = 48V (Longitudinal Orientation, Airflow from Input to Output, With 0.5" Height Heat Sink ELL050A)

Digital Feature Descriptions

The module has a digital PMBus interface to allow the module to be monitored, controlled and configured by the system. The module supports 4 PMBus signal lines, Data, Clock, SMBALERT (optional), Control (C2 pin, optional), and 2 Address line Addr0 and Addr1. More detail PMBus information can be found in the PMB Power Management Protocol Specification, Part I and part II, revision 2.2; which is shown in <http://pmbus.org>. Both 100kHz and 400kHz bus speeds are supported by the module. Connection for the PMBus interface should be following the High Power DC specifications given in section 3.1.3 in the SMBus specification V2.0 or the Low Power DC specifications in section 3.1.2. The complete SMBus specification is shown in <http://smbus.org>.

The module supports the Packet Error Checking (PEC) protocol. It can check the PEC byte provided by the PMBus master, and include a PEC byte in all message responses to the master. And the module also can communicate with the master that does not implement the PEC mechanism.

SMBALERT protocol is also supported by the module. SMBALERT line is also a wired-AND signal; by which the module can alert the PMBUS master via pulling the SMBALERT pin to an active low. There is only one way that the master and the module response to the alert of SMBALERT line.

This way is for the module used in a system that does not support Alert Response Address (ARA). The module is to retain its resistor programmed address, when it is in an ALERT active condition. The master will communicate with the slave module using the programmed address, and using the various READ_STATUS commands to find who cause for the SMBALERT. The CLEAR_FAULTS command will clear the SMBALERT.

The module contains a data flash used to store configuration settings, which will not be programmed into the device data flash automatically. The STORE_DEFAULT_ALL command must be used to commit the current settings are transfer from RAM to data flash as device defaults.

PMBUS Addressing

The Module has flexible PMBUS addressing capability. When connect different resistor from Addr0 and Addr1 pin to GND pin, 64 possible addresses can be acquired. The address is in the form of octal digits; Each pin offers one octal digit, and then combine together to form the decimal address as shown in below.

$$\text{Address} = 8 * \text{ADDR1} + \text{ADDR0}$$

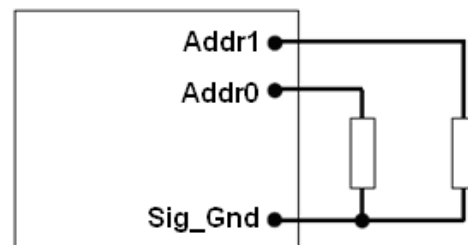

Corresponded to each octal digit, the requested resistor values are shown in below, and +/-1% resistors accuracy can be accepted. If there are any resistances exceeding the requested range, address 126 will be return. 0-12 and 40, 44, 45, 55 and 63 in decimal address can't be used, since they are reserved according to the SMBus specifications, and which will also return address 126.

Octal digit	Resistor(Kohm)
0	10
1	15.4
2	23.7
3	36.5
4	54.9
5	84.5
6	130
7	200

PMBus Data Format

The module receives and report date in LINEAR format. The Exponent of the data words is fixed at a reasonable value for the command; altering the exponent is not supported. DIRECT format is not supported by the module.

For commands that set or report any voltage thresholds related to the output voltage, the module supports the linear data format consisting of a two-byte value with a 16-bit, unsigned mantissa, and a fixed exponent of -9. The format of the two data bytes is shown below:

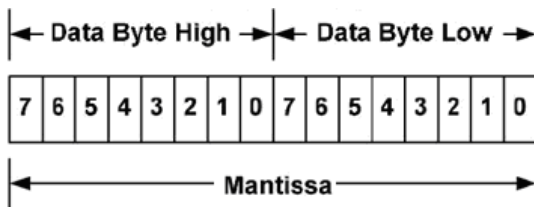

The equation can be written as:

$$V_{out} = \text{Mantissa} \times 2^{(-9)}$$

For example, considering set V_{out} to 12V by VOUT_COMMAND, the read/write data can be calculated refer to below process:

$$\text{Mantissa} = V_{out} / 2^{(-9)} = 12 / 2^{(-9)} = 6144;$$

Converter the calculated Mantissa to hexadecimal 0x1800.

For commands that set or report all other thresholds, including input voltages, output current, temperature, time and frequency, the supported linear data format is a two-byte value with: an 11 bit, two's complement mantissa, and a 5 bit, two's complement exponent (scaling factor). The format of the two data bytes is shown as in below.

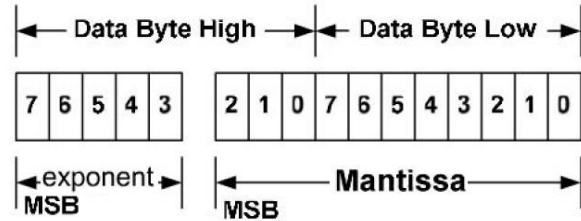

The equation can be written as:

$$\text{Value} = \text{Mantissa} \times 2^{(\text{exponent})}$$

For example, considering set the turn on threshold of input under voltage lockout to 34V by VIN_ON command; the read/write data can be calculated refer to below process:

Get the exponent of V_{in} , -3; whose binary is 11101

$$\text{Mantissa} = V_{in} / 2^{(-3)} = 34 / 2^{(-3)} = 272;$$

Converter the calculated Mantissa to hexadecimal 110, then converter to binary 00100010000; Combine the exponent and the mantissa, 11101 and 00100010000; Converter binary 1110100100010000 to hexadecimal E910.

Supported PMBus Commands

The main PMBus commands described in the PMBus 2.0 specification are supported by the module. Partial PMBus commands are fully supported; Partial PMBus commands have difference with the definition in PMBus 2.0 specification. All the supported PMBus commands are detail summarized in below table

Command	Command Code	Command description	Transfer type	Compatible with standard PMBUS or not?	Data Format	Default value	Range limit	Data units	Exponent	Note
OPERATION	0x01	Turn the module on or off by PMBUS command	R/W byte	Refer to below description;	Bit field	0x80	/	/	/	/
ON_OFF_CONFIG	0x02	Configures the combination of primary on/off pin and PMBus command	R/W byte	Not support turn off delay and fall time setup	Bit field	0x1D	/	/	/	0x1D (Neg Logic); 0x1F (Pos Logic);
CLEAR_FAULTS	0x03	Clear any fault bits that have been set	Send byte	Yes	/	/	/	/	/	/
WRITE_PROTECT	0x10	Control writing to the PMBUS device.	R/W byte	Yes	/	0x80	/	/	/	To protect accidental changes.
STORE_DEFAULT_ALL	0x11	Stores operating parameters from RAM to data flash	Send byte	Yes	/	/	/	/	/	This command is effective to the parameter of all command in this table.
RESTORE_DEFAULT_ALL	0x12	Restores operating parameters from data flash to RAM	Send byte	Yes	/	/	/	/	/	This command can't be issued when the power unit is running.
VOUT_MODE	0x20	Read Vo data format	Read byte	Yes	mode+exp	0x17	/	/	/	/
VOUT_COMMAND	0x21	Set the output voltage normal value	R/W word	Yes	Vout Linear	12	8 ~13.2	Volts	-9	/
VOUT_MARGIN_HIGH	0x25	Set the output voltage margin high value	R/W word	Yes	Vout Linear	12.6	8.4 ~13.8	Volts	-9	/
VOUT_MARGIN_LOW	0x26	Set the output voltage margin low value	R/W word	Yes	Vout Linear	11.4	7.6 ~12.4	Volts	-9	/
FREQUENCY_SWITCH	0x33	Read switching frequency	Read word	Yes	Frequency linear	250	/	KHz	-2	
VIN_ON	0x35	Set the turn on voltage threshold of Vin under voltage lockout	R/W word	Yes	Vin Linear	34.5	33~36	V	-3	VIN_ON should be higher than VIN_OFF
VIN_OFF	0x36	Set the turn off voltage threshold of Vin under voltage lockout	R/W word	Yes	Vin Linear	33	32~35	V	-3	VIN_ON should be higher than VIN_OFF
VOUT_OV_FAULT_LIMIT	0x40	Set the output overvoltage fault threshold.	R/W word	Yes	Vout Linear	15	11~17	V	-9	Must be higher than the value of VOUT_COMMAND and VOUT_OV_WARN_LIMIT;
VOUT_OV_WARN_LIMIT	0x42	Set a threshold causing an output voltage high warning.	R/W word	Yes	Vout Linear	14	10~16	V	-9	Must be the same or less than VOUT_OV_FAULT_LIMIT value
IOUT_OC_FAULT_LIMIT	0x46	Set the output overcurrent fault threshold.	R/W word	Yes	Iout Linear	46	34~50	A	-4	Must be greater than IOUT_OC_WARN_LIMIT value
IOUT_OC_WARN_LIMIT	0x4A	Set a threshold causing an output current high warning.	R/W word	Yes	Iout Linear	42	33~49	A	-4	Must be less than IOUT_OC_FAULT_LIMIT value

Command	Command Code	Command description	Transfer type	Compatible with standard PMBUS or not?	Data Format	Default value	Range limit	Data units	Exponent	Note
OT_FAULT_LIMIT	0x4F	Set the over temperature fault threshold.	R/W word	Yes	TEMP Linear	135	25~140	Deg .C	-2	Must be greater than OT_WARN_LIMIT value
OT_WARN_LIMIT	0x51	Set a threshold causing a temperature high warning.	R/W word	Yes	TEMP Linear	120	25~140	Deg .C	-2	Must be less than OT_FAULT_LIMIT value
VIN_OV_FAULT_LIMIT	0x55	Set the input overvoltage fault threshold.	R/W word	Yes	Vin Linear	105	48~105	V	-3	Endure Transient (100V/100ms)
POWER_GOOD_ON	0x5E	Sets the output voltage at which the bit 3 of STATUS_WORD high byte should be asserted.	R/W word	Yes	Vout Linear	9.6	6~11	V	-9	Must be greater than POWER_GOOD_OFF value
POWER_GOOD_OFF	0x5F	Sets the output voltage at which the bit 3 of STATUS_WORD high byte should be negated.	R/W word	Yes	Vout Linear	9	5~10	V	-9	Must be less than POWER_GOOD_ON value
STATUS_WORD	0x79	Returns the information with a summary of the module's fault/warning	Read word	Refer to below description;	Bit field	/	/	/	/	/
STATUS_VOUT	0x7A	Returns the information of the module's output voltage related fault/warning	R/W byte	Refer to below description;	Bit field	/	/	/	/	/
STATUS_IOUT	0x7B	Returns the information of the module's output current related fault/warning	R/W byte	Refer to below description;	Bit field	/	/	/	/	/
STATUS_INPUT	0x7C	Returns the information of the module's input over voltage and under voltage fault	R/W byte	Refer to below description;	Bit field	/	/	/	/	/
STATUS_TEMPERATURE	0x7D	Returns the information of the module's temperature related fault/warning	R/W byte	Refer to below description;	Bit field	/	/	/	/	/
STATUS_CML	0x7E	Returns the information of the module's communication related faults.	R/W byte	Refer to below description;	Bit field	/	/	/	/	/
READ_VIN	0x88	Returns the input voltage of the module	Read word	Yes	Vin Linear	/	/	V	-3	/
READ_VOUT	0x8B	Returns the output voltage of the module	Read word	Yes	Vout Linear	/	/	V	-9	/
READ_IOUT	0x8C	Returns the output current of the module	Read word	Yes	Iout Linear	/	/	A	-4	/
READ_TEMPERATURE_1	0x8D	Returns the module's hot spot temperature of the module	Read word	Yes	TEMP Linear	/	/	Deg .C	-2	/
PMBUS_REVISION	0x98	Reads the revision of the PMBus	Read byte	Yes	Bit field	0x22	/	/	/	/
PMBUS_CMD_MFR_ID	0x99	Read the manufacturer's ID	Read block	Yes	string	"DELTA"	/	/	/	Data that read should be converted to ASCII code
PMBUS_CMD_MFR_MODEL	0x9A	Read the manufacturer's model name	Read block	Yes	string	"E48S K12038 NRAH"	/	/	/	
PMBUS_CMD_MFR_LABEL_VERSION	0x9B	Read the label version	Read block	Yes	string	"SXX.XX"	/	/	/	
PMBUS_CMD_MFR_LOCATION	0x9C	Read the manufacturer's location	Read block	Yes	string	"THAILAND"	/	/	/	
PMBUS_CMD_MFR_SERIAL	0x9E	Read the module serial number	Read block	Yes	string	"XXXXX XXXXX XX"	/	/	/	
MFR_FW_VERSION	0xD1	Read the module FW version	Read block	Yes	string	"SXX.XX"	/	/	/	
MFR_C1_C2_ARA_CONFIG	0xE0	Config C2 pin function	R/W byte	Refer to below description;	Bit field	0x00	/	/	/	/
MFR_C2_Configure	0xE1	Config C2 pin logic	R/W byte	Refer to below description;	Bit field	0x00	/	/	/	/
MFR_PGOOD_POLARITY	0xE2	Config Power Good logic	R/W byte	Refer to below description;	Bit field	0x01	/	/	/	/
MFR_SERIAL	0x9E	Reads the SN of module	Read block	/	Total 11 ASCII characters	'xxxxxx xxxxx'	/	/	/	The SN number of module use 11 ASCII characters

OPERATION [0x01]

Bit number	Purpose	Bit Value	Meaning	Default Settings, 0x80
7:	Enable/Disable the module	1	Output is enabled	1
		0	Output is disabled	
6:	Reserved			0
5:4	Margins	00	No margin	00
		01	Margin low(Act on Fault)	
		10	Margin high(Act on Fault)	
3:0	Reserved			0000

STATUS_WORD [0x79]
High byte

Bit number	Purpose	Bit Value	Meaning
7	An output voltage fault or warning	1	Occurred
		0	No Occurred
6	An output over current fault or warning	1	Occurred
		0	No Occurred
5	An input voltage fault, including over voltage and under voltage	1	Occurred
		0	No Occurred
4	Reserved		
3	Power_Good	1	is negated
		0	ok
2:0	Reserved		

Low byte

Bit number	Purpose	Bit Value	Meaning
7	Reserved		
6	OFF (The unit is not providing power to the output, regardless of the reason)	1	Occurred
		0	No Occurred
5	An output over voltage fault	1	Occurred
		0	No Occurred
4	An output over current fault	1	Occurred
		0	No Occurred
3	An input under voltage fault	1	Occurred
		0	No Occurred
2	A temperature fault or warning	1	Occurred
		0	No Occurred
1	CML (A communications, memory or logic fault)	1	Occurred;
		0	No Occurred
0	Reserved		

STATUS_VOUT [0x7A]

Bit number	Purpose	Bit Value	Meaning
7	Output over voltage fault	1	Occurred;
		0	No Occurred
6	Output over voltage warning	1	Occurred;
		0	No Occurred
5	Output under voltage warning	1	Occurred;
		0	No Occurred
4	Output under voltage fault	1	Occurred;
		0	No Occurred
3:0	Reserved		

STATUS_IOUT [0x7B]

Bit number	Purpose	Bit Value	Meaning
7	Output over current fault	1	Occurred
		0	No Occurred
6	Reserved		
5	Output over current warning	1	Occurred
		0	No Occurred
4:0	Reserved		

STATUS_INPUT [0x7C]

Bit number	Purpose	Bit Value	Meaning
7	Input over voltage fault	1	Occurred
		0	No Occurred
6	Input over voltage warning	1	Occurred
		0	No Occurred
5	Input under voltage warning	1	Occurred
		0	No Occurred
4	Input under voltage fault	1	Occurred
		0	No Occurred
3:0	Reserved		

STATUS_TEMPERATURE [0x7D]

Bit number	Purpose	Bit Value	Meaning
7	Over temperature fault	1	Occurred
		0	No Occurred
6	Over temperature warning	1	Occurred
		0	No Occurred
5:0	Reserved		

STATUS_CML [0x7E]

Bit number	Purpose	Bit Value	Meaning
7	Invalid/Unsupported Command Received	1	Occurred
		0	No Occurred
6	Invalid/Unsupported Data Received	1	Occurred
		0	No Occurred
5	Packet Error Check Failed	1	Occurred
		0	No Occurred
4:0	Reserved		

MFR_C1_C2_ARA_CONFIG [0xE0]

Bit number	Purpose	Bit Value	Meaning
7:5	Reserved	000	Reserved
4	ARA	0	ARA not functional, module remains at resistor programmed address when SMBLAERT is asserted
3:0	PIN Configuration	0000	C2 pin: POWER_GOOD
		0010	C2 pin: ON/OFF (Secondary)

MFR_C2_Configure [0xE1]

Bit number	Purpose	Bit Value	Meaning
7:2	Reserved	000000	Reserved
1	ON/OFF Configuration	0	Secondary side on/off pin state when mapped to C2 is ignored
		1	AND – Primary and Secondary side on/off
0	Secondary Side ON/OFF Logic	0	Negative Logic (Low Enable: Input < 0.8V wrt Vout(-))
		1	Positive Logic (High Enable: Input > 2.0V wrt Vout(-))

MFR_PGOOD_POLARITY [0xE2]

Bit number	Purpose	Bit Value	Meaning
7:1	Reserved	0000000	Reserved
0	Power Good Logic	0	Negative PGOOD logic
		1	Positive PGOOD logic

Mechanical Drawing (With Heat-spreader)

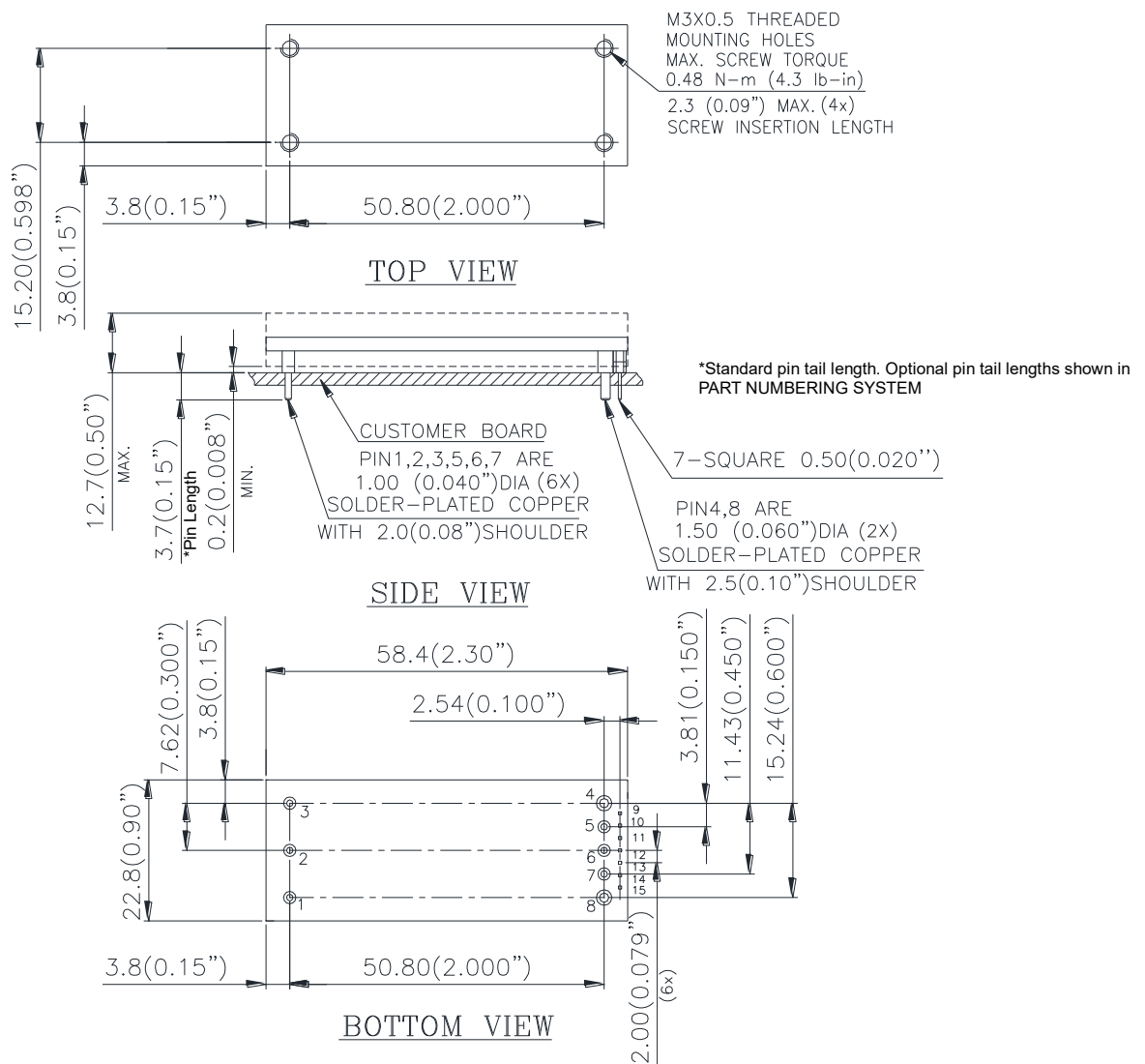

Pin#	Function	D_pin	Pin#	Function	D_pin
1	VIN(+)	∅ 1.00	9	C2	SQ0.5
2	ON/OFF	∅ 1.00	10	SIG_GND	SQ0.5
3	VIN(-)	∅ 1.00	11	DATA	SQ0.5
4	VOUT(-)	∅ 1.50	12	SMBALERT	SQ0.5
5	SENSE(-)	∅ 1.00	13	CLK	SQ0.5
6	TRIM	∅ 1.00	14	ADDR1	SQ0.5
7	SENSE(+)	∅ 1.00	15	ADDR0	SQ0.5
8	VOUT(+)	∅ 1.50			

NOTES:

DIMENSIONS ARE IN MILLIMETERS AND (INCHES)

TOLERANCES: X.Xmm±0.5mm(X.XX in.±0.02 in.)

X.XXmm±0.25mm(X.XXX in.±0.010 in.)

Pin Specification:

Pins 1,2,3,5,6,7

Pins 4,8

Pins 9-15

1.00mm (0.040") diameter; copper with matte Tin plating and Nickel under plating

1.50mm (0.060") diameter; copper with matte Tin plating and Nickel under plating

SQ 0.50mm(0.020") (All pins are copper with gold flash plating)

Recommended Pad Layout

RECOMMENDED P.W.B. PAD LAYOUT

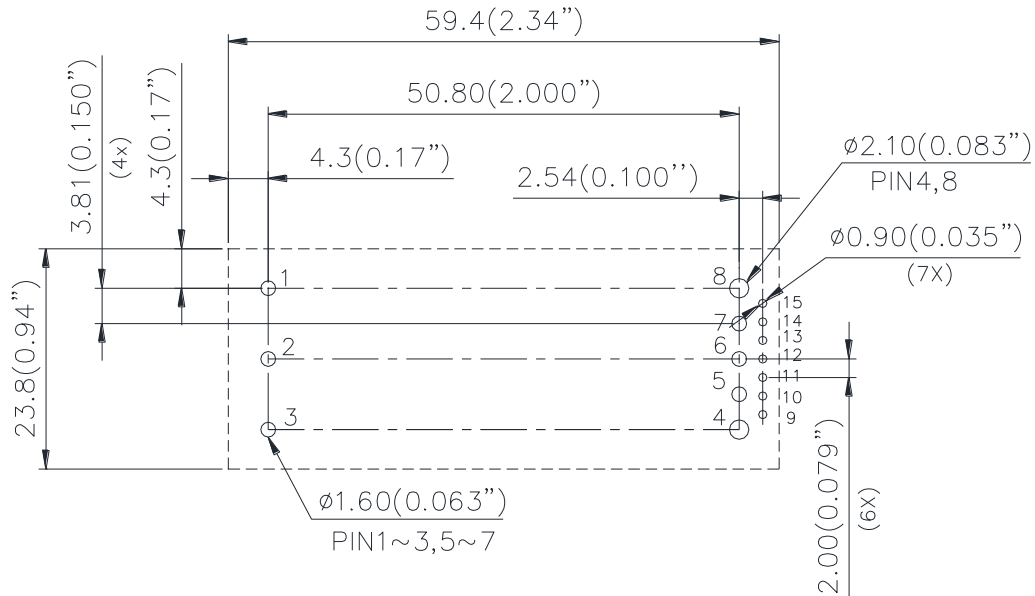

Pin#	Function	D_pin	Pin#	Function	D_pin
1	VIN(+)	∅1.00	9	C2	SQ0.5
2	ON/OFF	∅1.00	10	SIG_GND	SQ0.5
3	VIN(-)	∅1.00	11	DATA	SQ0.5
4	VOUT(-)	∅1.50	12	SMBALERT	SQ0.5
5	SENSE(-)	∅1.00	13	CLK	SQ0.5
6	TRIM	∅1.00	14	ADDR1	SQ0.5
7	SENSE(+)	∅1.00	15	ADDR0	SQ0.5
8	VOUT(+)	∅1.50			

NOTES:

DIMENSIONS ARE IN MILLIMETERS AND (INCHES)

TOLERANCES: X.Xmm±0.5mm(X.XX in.±0.02 in.)

X.XXmm±0.25mm(X.XXX in.±0.010 in.)

Soldering Method

Generally, as the most common mass soldering method for the solder attachment, wave soldering is used for through-hole power modules and reflow soldering is used for surface-mount ones. Delta recommended soldering methods and process parameters are provided in this document for solder attachment of power modules onto system board. SAC305 is the suggested lead-free solder alloy for all soldering methods. The soldering temperature profile presented in this document is based on SAC305 solder alloy.

Reflow soldering is not a suggested method for through-hole power modules due to many process and reliability concerns. If you have this kind of application requirement, please contact Delta sales or FAE for further confirmation.

Wave Soldering (Lead-free)

Delta's power modules are designed to be compatible with single-wave or dual wave soldering. The suggested soldering process must keep the power module's internal temperature below the critical temperature of 217°C continuously. The recommended wave-soldering profile is shown below:

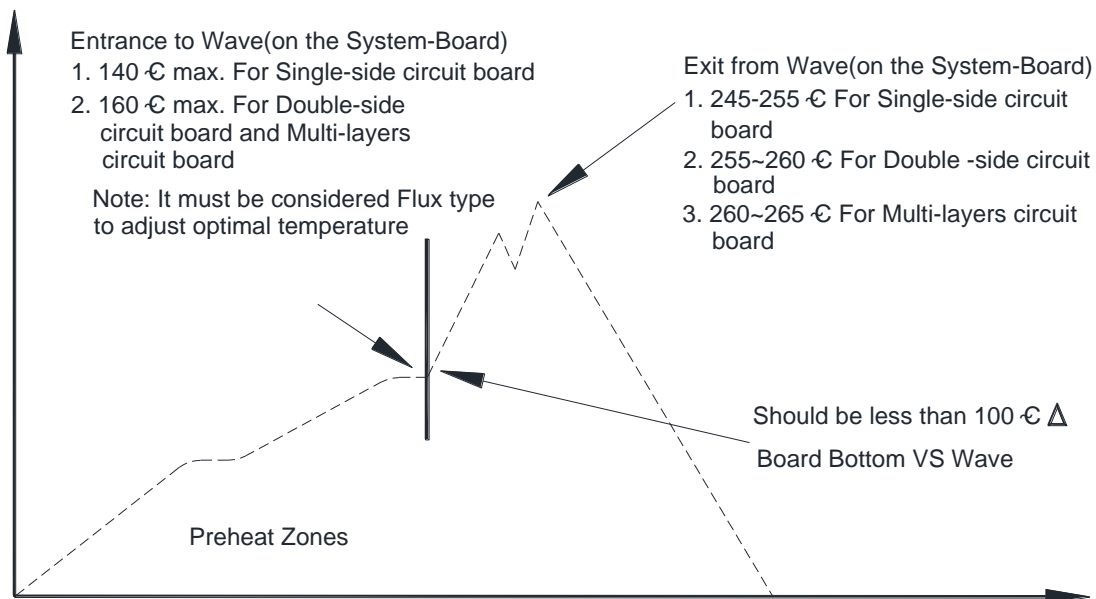

Note: The temperature is measured on solder joint of pins of power module.

The typical recommended (for double-side circuit board) preheat temperature is 115+/-10°C on the top side (component side) of the circuit board. The circuit-board bottom-side preheat temperature is typically recommended to be greater than 135°C and preferably within 100°C of the solder-wave temperature. A maximum recommended preheat up rate is 3°C /s. A maximum recommended solder pot temperature is 255+/-5°C with solder-wave dwell time of 3~6 seconds. The cooling down rate is typically recommended to be 6°C/s maximum.

Hand Soldering (Lead Free)

Hand soldering is the least preferred method because the amount of solder applied, the time the soldering iron is held on the joint, the temperature of the iron, and the temperature of the solder joint are variable. The recommended hand soldering guideline is listed in Table below. The suggested soldering process must keep the power module's internal temperature below the critical temperature of 217°C continuously.

Parameter	Single-side Circuit Board	Double-side Circuit Board	Multi-layers Circuit Board
Soldering Iron Wattage	90	90	90
Tip Temperature	385+/-10°C	420+/-10°C	420+/-10°C
Soldering Time	2 ~ 6 seconds	4 ~ 10 seconds	4 ~ 10 seconds

Reflow Soldering (Lead-free)

High temperature and long soldering time will result in IMC layer increasing in thickness and thereby shorten the solder joint lifetime. Therefore the peak temperature over 245°C is not suggested due to the potential reliability risk of components under continuous high-temperature. In the meanwhile, the soldering time of temperature above 217°C should be less than 60 seconds, and the cooling down rate should be less than 2°C/minutes. Please refer to following fig for recommended temperature profile parameters.

Shielding cap is requested to mount on DCDC module if with heat-spreader/heat-sink, to prevent the customer side high temperature of reflow to re-melt the DCDC module's internal component's soldering joint.

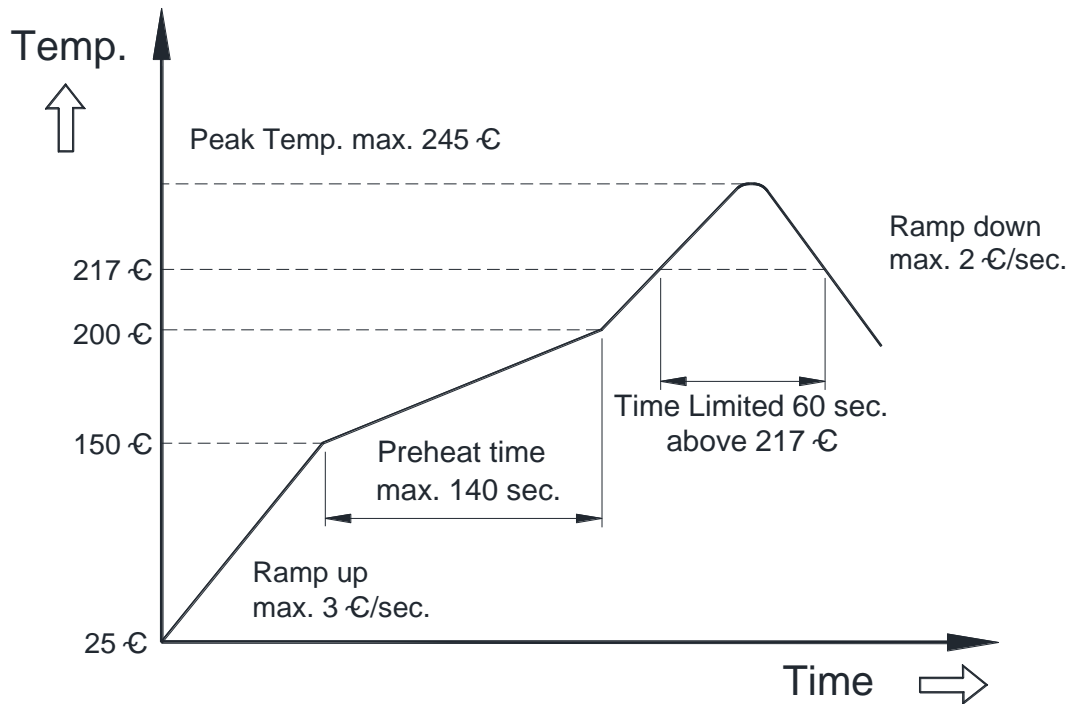

Note: The temperature is measured on solder joint of pins of power module.

PART NUMBERING SYSTEM

E	48	S	K	120	38	N	R	A (Note)	H
Type of Product	Input Voltage	Number of Outputs	Product Series	Output Voltage	Output Current	ON/OFF Logic	Pin Length /Type	Pin Assignment	Option code
E - Eighth Brick	48 - 36~75V	S - Single	K - Series number	120 - 12V	38 - 37.5A	P - Positive N - Negative R - Negative and compliant reflow process	R - 0.170" N - 0.145"	A - Analog pins D - Digital pins I - IBC pins *Note	H - With baseplate

*Note for mechanical pins option:

1. A - Analog pins: without digital pins(pin9~15).
2. D - Digital pins*: with all pins on mechanical drawing.
3. I - IBC pins* : without digital pins (pin9~pin15) & without sense pins (pin5, pin7) & without Trim pins (pin6).

RECOMMENDED PART NUMBER

Model Name	Input	Output	Peak Eff.
E48SK12038NRDH	36V~75V	12V 37.5A	96%
E48SK12038NNDH	36V~75V	12V 37.5A	96%
E48SK12038RNDH	36V~75V	12V 37.5A	96%
E48SK12038RNAH	36V~75V	12V 37.5A	96%

Please contact with Delta sales/FAE for different optional functions.

CONTACT US:

Website: www.deltaww.com/dcdc

Email: dcdc@deltaww.com

USA:

Telephone:
East Coast: 978-656-3993
West Coast: 510-668-5100
Fax: 510-668-0680

Europe:

Telephone: +31-20-800-3900
Fax: +31-20-800-3999

Asia & the rest of world:

Telephone: +886-3-452-6107
Ext. 6221~6226
Fax: +886-3-433-1810

WARRANTY

Delta offers a two (2) year limited warranty. Complete warranty information is listed on our web site or is available upon request from Delta.

Information furnished by Delta is believed to be accurate and reliable. However, no responsibility is assumed by Delta for its use, nor for any infringements of patents or other rights of third parties, which may result from its use. No license is granted by implication or otherwise under any patent or patent rights of Delta. Delta reserves the right to revise these specifications.